

70437E.59.097

Mitigeur thermostatique à encastrer 3 sorties, avec commande pour le réglage de la température et boutons on/off. Façade murale - finition PVD Brushed Gold

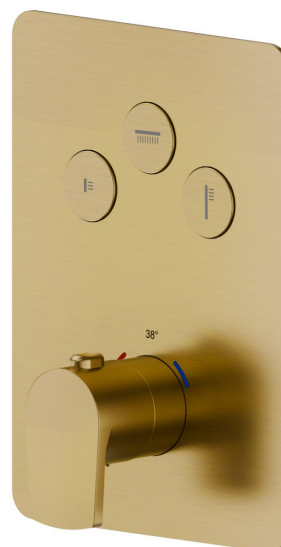

CARACTÉRISTIQUES

Matériau	Laiton
Installation	Boîte d'encastrement mural
Sorties	3 Sorties
Mitigeur d'eau	Thermostatique
Nécessaires à l'installation	<u>27752.00.000</u>

DESSIN TECHNIQUE

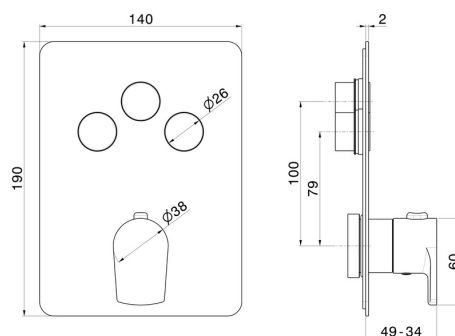



70437E.59.097

Mitigeur thermostatique à encastrer 3 sorties, avec commande pour le réglage de la température et boutons on/off. Façade murale - finition PVD Brushed Gold

FINITIONS DISPONIBLES



59.097

PVD Brushed Gold



01.014

finition Matt White



01.093

finition Matt Black



21.018

finition Chrome



59.064

finition PVD Brushed Gun Metal



59.066

finition PVD Brushed steel



59.067

finition PVD Brushed Copper Bronze