

70453E.21.018

Mitigeur thermostatique à encastrer 3 sorties, avec commande pour le réglage de la température et boutons on/off. Façade murale - finition Chrome



CARACTÉRISTIQUES

Matériau	Laiton
Installation	Boîte d'encastrement mural
Sorties	3 Sorties
Mitigeur d'eau	Thermostatique
Nécessaires à l'installation	<u>27752.00.000</u>

DESSIN TECHNIQUE

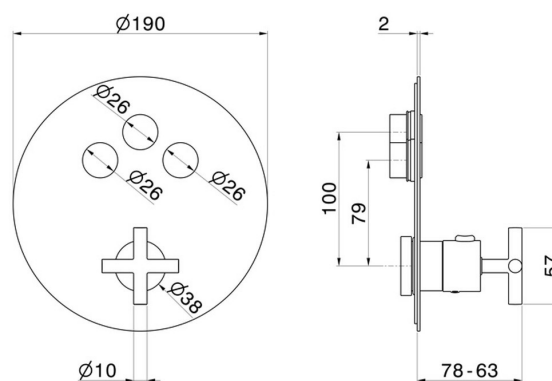



70453E.21.018

Mitigeur thermostatique à encastrer 3 sorties, avec commande pour le réglage de la température et boutons on/off. Façade murale - finition Chrome

FINITIONS DISPONIBLES



21.018

Chrome



01.093

finition Matt Black



47.083

finition Groove Bronze



58.061

finition PVD Copper Bronze



58.063

finition PVD Gun Metal



59.098

finition PVD Brushed Pale Gold



61.020

finition PVD Glossy Gold