

70459ex.59.098

Mitigeur thermostatique à encastrer 3 sorties, avec commande pour le réglage de la température et boutons on/off. Façade murale - finition PVD Brushed Pale Gold



CARACTÉRISTIQUES

Matériau	Acier inox
Installation	Boîte d'encastrement mural
Sorties	3 Sorties
Mitigeur d'eau	Thermostatique
Nécessaires à l'installation	<u>27752.00.000</u>

DESSIN TECHNIQUE

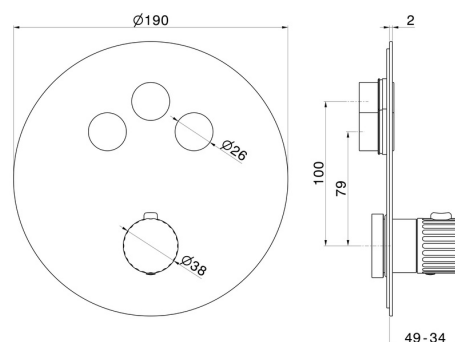



70459ex.59.098

Mitigeur thermostatique à encastrer 3 sorties, avec commande pour le réglage de la température et boutons on/off. Façade murale - finition PVD Brushed Pale Gold

FINITIONS DISPONIBLES



59.098

PVD Brushed Pale Gold



50.050

finition Stainless Steel



59.064

finition PVD Brushed Gun Metal



59.067

finition PVD Brushed Copper Bronze