

## 73428E.58.061

Mitigeur thermostatique à encastrer, avec commande pour le réglage de la température et inverseur 2 sorties. Ø170. Façade murale. LUXURY - finition PVD Copper Bronze

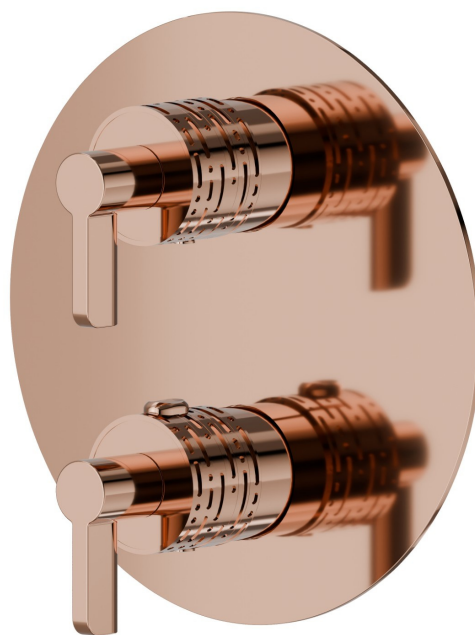

### CARACTÉRISTIQUES

Matériau	<b>Laiton</b>
Installation	<b>Boîte d'encastrement mural</b>
Type de commande	<b>Monocommande</b>
Type d'inverseur	<b>Inverseur mécanique</b>
Sorties	<b>2 Sorties</b>
Mitigeur d'eau	<b>Thermostatique</b>
Nécessaires à l'installation	<b><u>31020.00.000</u></b>
Nécessaires à l'installation	<b><u>31061.00.000</u></b>

### DESSIN TECHNIQUE

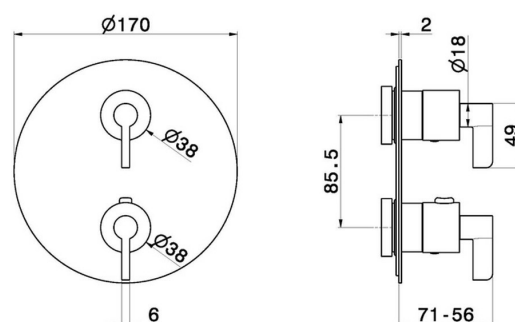

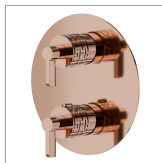



**73428E.58.061**

Mitigeur thermostatique à encastrer, avec commande pour le réglage de la température et inverseur 2 sorties. Ø170. Façade murale.LUXURY - finition PVD Copper Bronze

**FINITIONS DISPONIBLES**

---

 **58.061**  
PVD Copper Bronze

 **01.093**  
finition Matt Black

 **21.018**  
finition Chrome

 **47.083**  
finition Groove Bronze

 **58.063**  
finition PVD Gun Metal

 **59.098**  
finition PVD Brushed Pale Gold

 **61.020**  
finition PVD Glossy Gold