

67608E.47.083

Mitigeur thermostatique à encastrer, avec commande pour le réglage de la température et inverseur 2 sorties. Façade murale - finition Groove Bronze

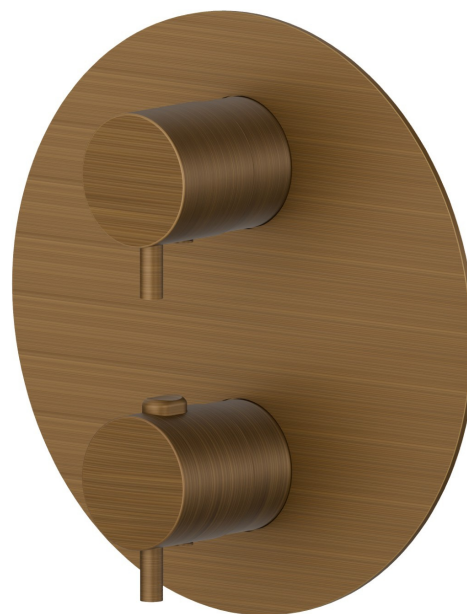

CARACTÉRISTIQUES

Matériau	Laiton
Installation	Boîte d'encastrement mural
Type d'inverseur	Inverseur mécanique
Sorties	2 Sorties
Mitigeur d'eau	Thermostatique
Nécessaires à l'installation	<u>27888.00.000</u>
Nécessaires à l'installation	<u>31020.00.000</u>
Nécessaires à l'installation	<u>31061.00.000</u>

DESSIN TECHNIQUE

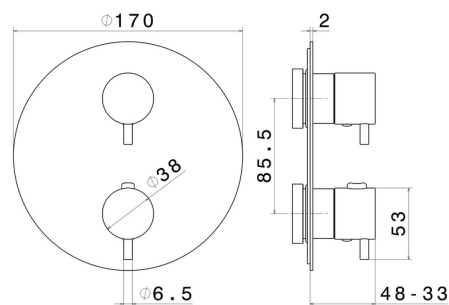

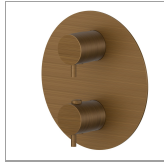

67608E.47.083

Mitigeur thermostatique à encastrer, avec commande pour le réglage de la température et inverseur 2 sorties. Façade murale - finition Groove Bronze

FINITIONS DISPONIBLES



47.083

Groove Bronze



01.014

finition Matt White



01.093

finition Matt Black



21.018

finition Chrome



58.061

finition PVD Copper Bronze



58.063

finition PVD Gun Metal



59.064

finition PVD Brushed Gun Metal



59.066

finition PVD Brushed steel



59.067

finition PVD Brushed Copper Bronze



59.097

finition PVD Brushed Gold



59.098

finition PVD Brushed Pale Gold





61.020

finition PVD Glossy Gold

 **MO.070**
finition Titanium Satin

 **MO.071**
finition Gold Satin

 **MO.072**
finition Copper Satin

 **MO.075**
finition Copper Glossy

 **MO.077**
finition Carbon Satin