

## 73436ex.59.064

Mitigeurs de douche thermostatiques à encastrer 2 sorties -  
finition PVD Brushed Gun Metal

Façade murale. Entrées et sorties de 3/4".



PVD Brushed Gun Metal

### CARACTÉRISTIQUES

Matériau	<b>Acier inox</b>
Installation	<b>Boîte d'encastrement mural</b>
Sorties	<b>2 Sorties</b>
Mitigeur d'eau	<b>Thermostatique</b>
Nécessaires à l'installation	<b><u>31063.00.000</u></b>

### DESSIN TECHNIQUE

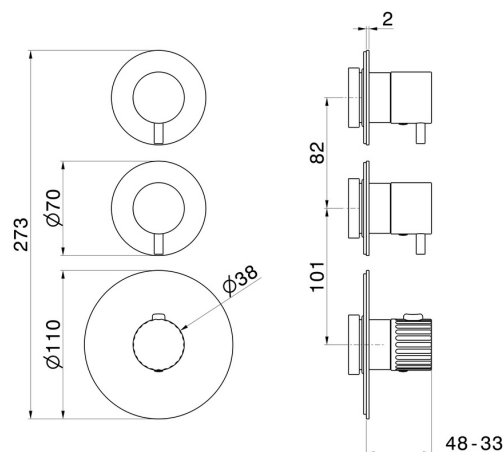



**73436ex.59.064**

Mitigeurs de douche thermostatiques à encastrer 2 sorties - finition PVD Brushed Gun Metal

## FINITIONS DISPONIBLES

---



**59.064**

PVD Brushed Gun Metal



**50.050**

finition Stainless Steel



**59.067**

finition PVD Brushed Copper Bronze



**59.098**

finition PVD Brushed Pale Gold