

73436ex.59.067

Mitigeurs de douche thermostatiques à encastrer 2 sorties -
 finition PVD Brushed Copper Bronze

Façade murale. Entrées et sorties de 3/4".



PVD Brushed Copper Bronze

CARACTÉRISTIQUES

Matériau	Acier inox
Installation	Boîte d'encastrement mural
Sorties	2 Sorties
Mitigeur d'eau	Thermostatique
Nécessaires à l'installation	<u>31063.00.000</u>

DESSIN TECHNIQUE

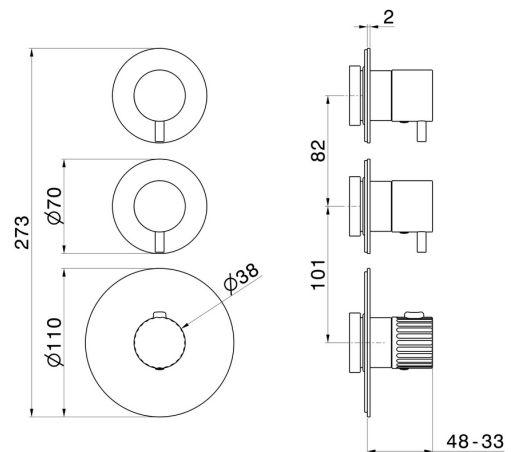



73436ex.59.067

Mitigeurs de douche thermostatiques à encastrer 2 sorties - finition PVD Brushed Copper Bronze

FINITIONS DISPONIBLES



59.067

PVD Brushed Copper Bronze



50.050

finition Stainless Steel



59.064

finition PVD Brushed Gun Metal



59.098

finition PVD Brushed Pale Gold