

69859EX.59.098

Mitigeurs de douche thermostatiques à encastrer 2 sorties.
entrées et sorties de 3/4". Façade murale. Ø70 - finition PVD
Brushed Pale Gold



PVD Brushed Pale Gold



CARACTÉRISTIQUES

Matériau	Acier inox
Installation	Boîte d'encastrement mural
Sorties	2 Sorties
Mitigeur d'eau	Thermostatique
Nécessaires à l'installation	<u>31063.00.000</u>

DESSIN TECHNIQUE

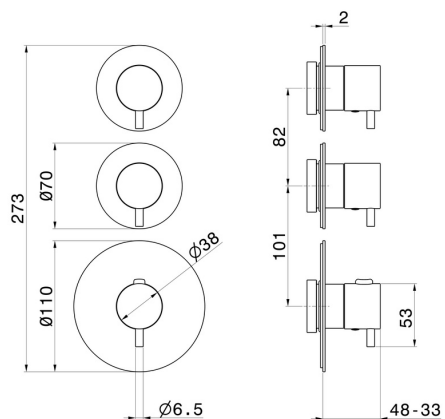



69859EX.59.098

Mitigeurs de douche thermostatiques à encastrer 2 sorties. entrées et sorties de 3/4". Façade murale. Ø70 - finition PVD Brushed Pale Gold

FINITIONS DISPONIBLES



59.098

PVD Brushed Pale Gold



50.050

finition Stainless Steel



59.064

finition PVD Brushed Gun Metal



59.067

finition PVD Brushed Copper Bronze



59.097

finition PVD Brushed Gold