

HAKA

72032E.59.064

Mitigeurs lavabo mural avec boîte d'encastrement - finition PVD
Brushed Gun Metal

Façade murale. Sans vidage



PVD Brushed Gun Metal

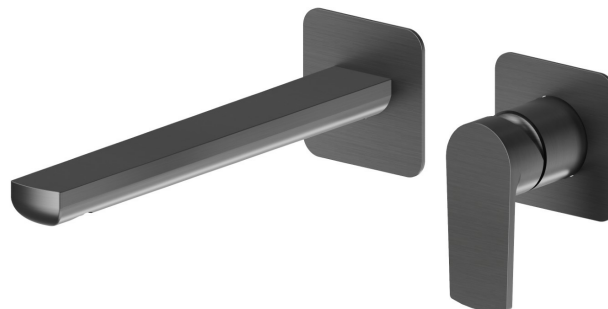

CARACTÉRISTIQUES

Matériau	Laiton
Technologie	Save Water
Installation	Boîte d'encastrement mural
Bec	Bec long
Type de perçage	2 trous
Type de commande	Monocommande
Vidage	Sans vidage
Mitigeur d'eau	Mécanique
Nécessaires à l'installation	<u>27852.00.000</u>

DESSIN TECHNIQUE

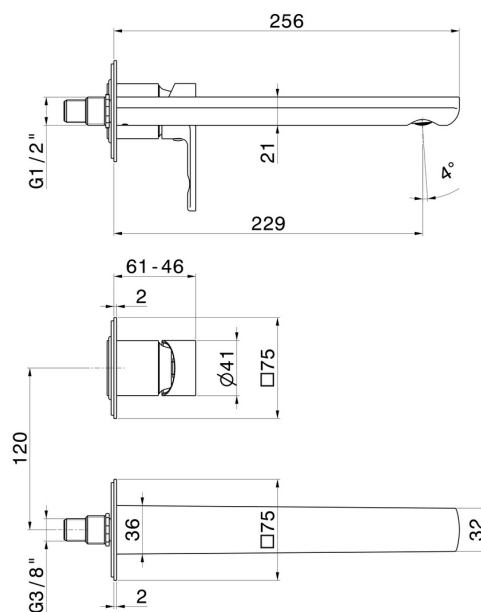



HAKA

72032E.59.064

Mitigeurs lavabo mural avec boîte d'encastrement - finition PVD Brushed Gun Metal

FINITIONS DISPONIBLES



59.064

PVD Brushed Gun Metal



01.014

finition Matt White



01.093

finition Matt Black



21.018

finition Chrome



59.066

finition PVD Brushed steel



59.067

finition PVD Brushed Copper Bronze



59.097

finition PVD Brushed Gold