

## 228.21.018

1"1/4 Abfluss mit freiem Ablauf - oberfläche Chrom



Chrom



### EIGENSCHAFTEN

Material	<b>Messing</b>
Ablaufgarnitur	<b>freiem Ablauf</b>

### TECHNISCHE ZEICHNUNG

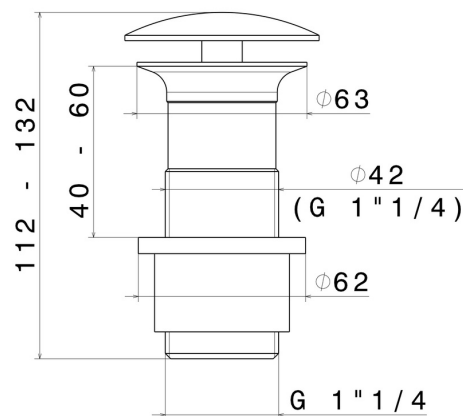



**228.21.018**

1"1/4 Abfluss mit freiem Ablauf - oberfläche Chrom

## VERFÜGBARE OBERFLÄCHEN

---



**21.018**

Chrom



**01.014**

oberfläche Weiß matt



**01.093**

oberfläche Schwarz matt



**47.083**

oberfläche Groove Bronze



**58.061**

oberfläche PVD Copper Bronze



**58.063**

oberfläche PVD Gun Metal



**59.064**

oberfläche PVD Gun Metal gebürstet



**59.066**

oberfläche PVD Edelstahl



**59.067**

oberfläche PVD Copper Bronze gebürstet



**59.097**

oberfläche PVD Gold gebürstet



**59.098**

oberfläche PVD Pale Gold gebürstet



**61.020**

oberfläche PVD Glossy Gold

 **MO.070**  
oberfläche Titanium Satin

 **MO.071**  
oberfläche Gold Satin

 **MO.072**  
oberfläche Copper Satin

 **MO.075**  
oberfläche Copper Glossy

 **MO.077**  
oberfläche Carbon Satin