

228.59.098

1"1/4 Abfluss mit freiem Ablauf - oberfläche PVD Pale Gold gebürstet



PVD Pale Gold gebürstet



EIGENSCHAFTEN

Material	Messing
Ablaufgarnitur	freiem Ablauf

TECHNISCHE ZEICHNUNG

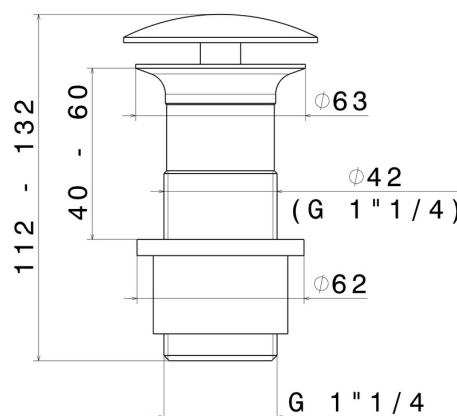



228.59.098

1"1/4 Abfluss mit freiem Ablauf - oberfläche PVD Pale Gold gebürstet

VERFÜGBARE OBERFLÄCHEN



59.098

PVD Pale Gold gebürstet



01.014

oberfläche Weiß matt



01.093

oberfläche Schwarz matt



21.018

oberfläche Chrom



47.083

oberfläche Groove Bronze



58.061

oberfläche PVD Copper Bronze



58.063

oberfläche PVD Gun Metal



59.064

oberfläche PVD Gun Metal gebürstet



59.066

oberfläche PVD Edelstahl



59.067

oberfläche PVD Copper Bronze gebürstet



59.097

oberfläche PVD Gold gebürstet



61.020

oberfläche PVD Glossy Gold

 **MO.070**
oberfläche Titanium Satin

 **MO.071**
oberfläche Gold Satin

 **MO.072**
oberfläche Copper Satin

 **MO.075**
oberfläche Copper Glossy

 **MO.077**
oberfläche Carbon Satin