

## 229.58.063

1"1/4 Abfluss mit freiem Ablauf - oberfläche PVD Gun Metal



PVD Gun Metal



### EIGENSCHAFTEN

---

Material  
Ablaufgarnitur

**Messing**  
**freiem Ablauf**

### TECHNISCHE ZEICHNUNG

---

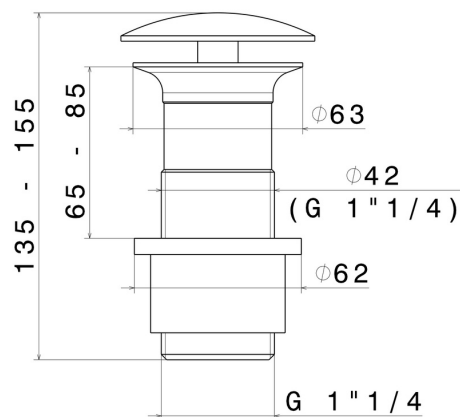



**229.58.063**

1"1/4 Abfluss mit freiem Ablauf - oberfläche PVD Gun Metal

## VERFÜGBARE OBERFLÄCHEN

---



**58.063**

PVD Gun Metal



**01.014**

oberfläche Weiß matt



**01.093**

oberfläche Schwarz matt



**21.018**

oberfläche Chrom



**47.083**

oberfläche Groove Bronze



**58.061**

oberfläche PVD Copper Bronze



**59.064**

oberfläche PVD Gun Metal gebürstet



**59.066**

oberfläche PVD Edelstahl



**59.067**

oberfläche PVD Copper Bronze gebürstet



**59.097**

oberfläche PVD Gold gebürstet



**59.098**

oberfläche PVD Pale Gold gebürstet



**61.020**

oberfläche PVD Glossy Gold

 **MO.070**  
oberfläche Titanium Satin

 **MO.071**  
oberfläche Gold Satin

 **MO.072**  
oberfläche Copper Satin

 **MO.075**  
oberfläche Copper Glossy

 **MO.077**  
oberfläche Carbon Satin