

232.47.083

1"1/4 Druckknopfablauf und Überlauf - oberfläche Groove Bronze



Groove Bronze



EIGENSCHAFTEN

Material
Ablaufgarnitur

Messing
Druckknopfablauf

TECHNISCHE ZEICHNUNG

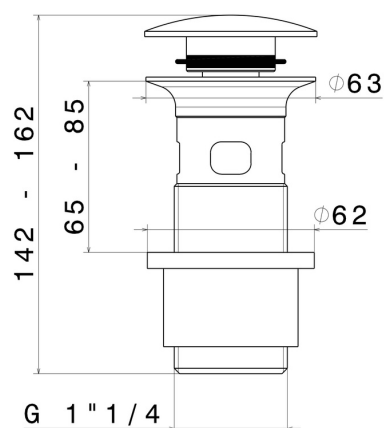



232.47.083

1"1/4 Druckknopfablauf und Überlauf - oberfläche Groove Bronze

VERFÜGBARE OBERFLÄCHEN



47.083

Groove Bronze



01.014

oberfläche Weiß matt



01.093

oberfläche Schwarz matt



21.018

oberfläche Chrom



58.061

oberfläche PVD Copper Bronze



58.063

oberfläche PVD Gun Metal



59.064

oberfläche PVD Gun Metal gebürstet



59.066

oberfläche PVD Edelstahl



59.067

oberfläche PVD Copper Bronze gebürstet



59.097

oberfläche PVD Gold gebürstet



59.098

oberfläche PVD Pale Gold gebürstet



61.020

oberfläche PVD Glossy Gold

 **MO.070**
oberfläche Titanium Satin

 **MO.071**
oberfläche Gold Satin

 **MO.072**
oberfläche Copper Satin

 **MO.075**
oberfläche Copper Glossy

 **MO.077**
oberfläche Carbon Satin