

LINFA II

69491.M0.070

Auslauf für Wannenrand - oberfläche Titanium Satin



EIGENSCHAFTEN

Material	Messing
Installation	wannenrandmontage
Lochtyp	1-Loch

TECHNISCHE ZEICHNUNG

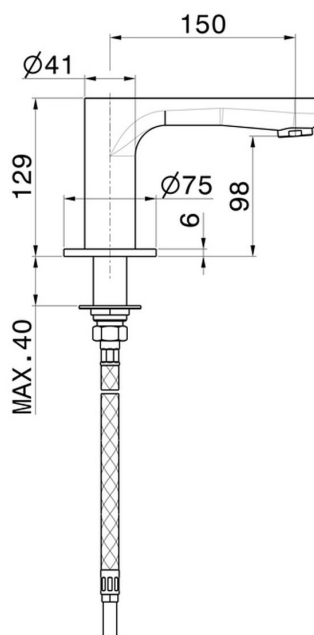









LINFA II

69491.M0.070

Auslauf für Wannenrand - oberfläche Titanium Satin

VERFÜGBARE OBERFLÄCHEN

-  **M0.070**
Titanium Satin
-  **01.014**
oberfläche Weiß matt
-  **01.093**
oberfläche Schwarz matt
-  **21.018**
oberfläche Chrom
-  **M0.071**
oberfläche Gold Satin
-  **M0.072**
oberfläche Copper Satin
-  **M0.075**
oberfläche Copper Glossy