

LINFA II

69469E.M0.070

Einbau-duscheinheit komplett mit handbrause und 2-wege-umstellung - oberfläche Titanium Satin

Außenteil

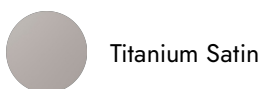

EIGENSCHAFTEN

Material	Messing
Technologie	Save Water
Installation	UP Körper
Umstellerart	mechanischer umstellung
Wasservermischung	mechanische
Für die Installation erforderlich	<u>31086.00.000</u>

TECHNISCHE ZEICHNUNG

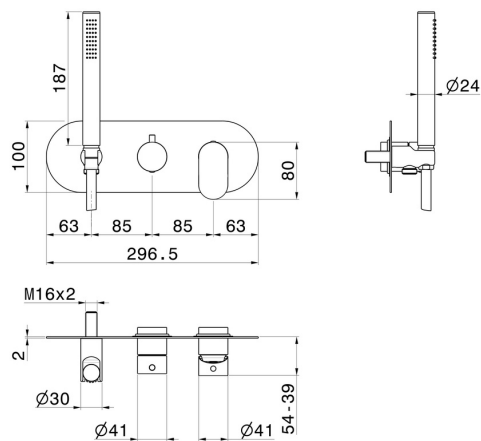









LINFA II

69469E.M0.070

Einbau-duscheinheit komplett mit handbrause und 2-wege-umstellung - oberfläche Titanium Satin

VERFÜGBARE OBERFLÄCHEN

-  **M0.070**
Titanium Satin
-  **01.014**
oberfläche Weiß matt
-  **01.093**
oberfläche Schwarz matt
-  **21.018**
oberfläche Chrom
-  **M0.071**
oberfläche Gold Satin
-  **M0.072**
oberfläche Copper Satin
-  **M0.075**
oberfläche Copper Glossy