

LINFA II

69425.M0.070

Einhebel-Mischbatterie für Bidet - oberfläche Titanium Satin



Titanium Satin



EIGENSCHAFTEN

| | |
|-------------------|------------------------|
| Material | Messing |
| Technologie | Save Water |
| Installation | Aufsatz |
| Lochtyp | 1-Loch |
| Bedienungsart | Einhebelmischer |
| Ablaufgarnitur | mit Ablauf |
| Wasservermischung | mechanische |

TECHNISCHE ZEICHNUNG

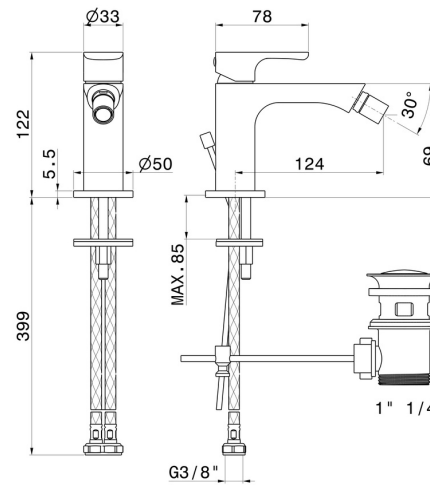









LINFA II

69425.M0.070

Einhebel-Mischbatterie für Bidet - oberfläche Titanium Satin

VERFÜGBARE OBERFLÄCHEN

-  **M0.070**
Titanium Satin
-  **01.014**
oberfläche Weiß matt
-  **01.093**
oberfläche Schwarz matt
-  **21.018**
oberfläche Chrom
-  **M0.071**
oberfläche Gold Satin
-  **M0.072**
oberfläche Copper Satin
-  **M0.075**
oberfläche Copper Glossy