

B-EASY

72625.M0.071

Einhebel-Mischbatterie für Bidet - oberfläche Gold Satin



Gold Satin



EIGENSCHAFTEN

Material	Messing
Technologie	Save Water
Installation	Aufsatz
Lochtyp	1-Loch
Bedienungsart	Einhebelmischer
Ablaufgarnitur	mit Ablauf
Wasservermischung	mechanische

TECHNISCHE ZEICHNUNG

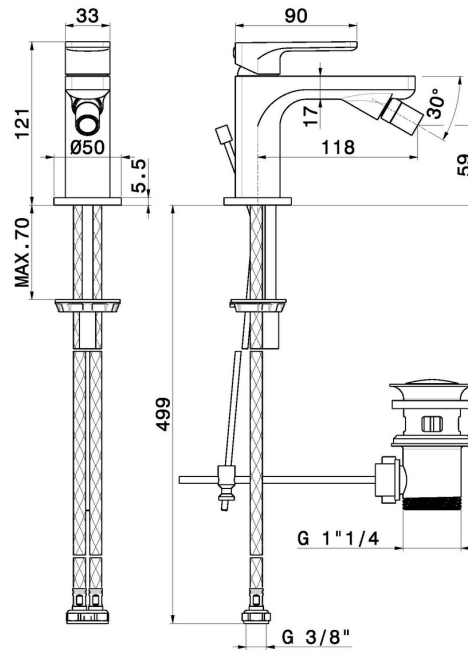



B-EASY

72625.M0.071

Einhebel-Mischbatterie für Bidet - oberfläche Gold Satin

VERFÜGBARE OBERFLÄCHEN

 **M0.071**
Gold Satin

 **01.014**
oberfläche Weiß matt

 **01.093**
oberfläche Schwarz matt

 **21.018**
oberfläche Chrom

 **M0.070**
oberfläche Titanium Satin

 **M0.072**
oberfläche Copper Satin

 **M0.075**
oberfläche Copper Glossy