

LINFA II

69410.M0.075

Einhebel-Waschtischarmatur - oberfläche Copper Glossy



EIGENSCHAFTEN

Material	Messing
Technologie	Save Water
Installation	Aufsatz
Ausführung	Standard
Lochtyp	1-Loch
Bedienungsart	Einhebelmischer
Ablaufgarnitur	mit Ablauf
Wasservermischung	mechanische

TECHNISCHE ZEICHNUNG

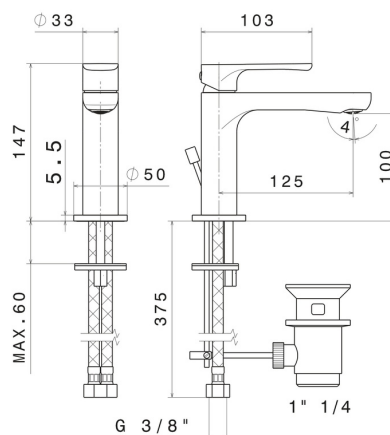



LINFA II

69410.M0.075

Einhebel-Waschtischarmatur - oberfläche Copper Glossy

VERFÜGBARE OBERFLÄCHEN

 **M0.075**
Copper Glossy

 **01.014**
oberfläche Weiß matt

 **01.093**
oberfläche Schwarz matt

 **21.018**
oberfläche Chrom

 **M0.070**
oberfläche Titanium Satin

 **M0.071**
oberfläche Gold Satin

 **M0.072**
oberfläche Copper Satin