

70404E.01.093

Thermostatischer einbaumischer mit 3-wege, mit bedienung zur temperaturregulierung und ein/aus-tasten. Außenteil - oberfläche Schwarz matt



EIGENSCHAFTEN

Material	Messing
Installation	UP Körper
Ausgänge	3 Wege
Wasservermischung	thermostatisch
Für die Installation erforderlich	<u>27752.00.000</u>

TECHNISCHE ZEICHNUNG

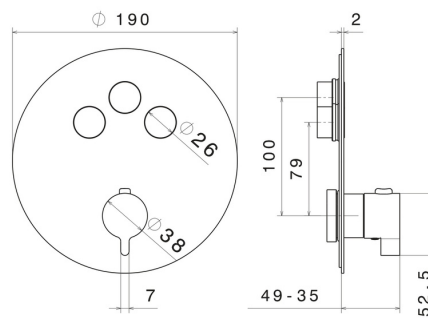



70404E.01.093

Thermostatischer einbaumischer mit 3-wege, mit bedienung zur temperaturregulierung und ein/aus-tasten. Außenteil - oberfläche Schwarz matt

VERFÜGBARE OBERFLÄCHEN



01.093

Schwarz matt



01.014

oberfläche Weiß matt



21.018

oberfläche Chrom



47.083

oberfläche Groove Bronze



58.061

oberfläche PVD Copper Bronze



58.063

oberfläche PVD Gun Metal



59.064

oberfläche PVD Gun Metal gebürstet



59.066

oberfläche PVD Edelstahl



59.067

oberfläche PVD Copper Bronze gebürstet



59.097

oberfläche PVD Gold gebürstet



61.020

oberfläche PVD Glossy Gold



M0.070

oberfläche Titanium Satin



MO.071

oberfläche Gold Satin



MO.072

oberfläche Copper Satin



MO.075

oberfläche Copper Glossy



MO.077

oberfläche Carbon Satin