

B-EASY

72672E.M0.075

Wandmontierte wannenbatterie - oberfläche Copper Glossy

Bestehend aus einbau-wannenmischbatterie mit umsteller, auslauf und brausegarnitur.



SAVE WATER



Copper Glossy



EIGENSCHAFTEN

Material	Messing
Technologie	Save Water
Installation	UP Körper
Umstellerart	mechanischer umstellung
Wasservermischung	mechanische
Für die Installation erforderlich	<u>31088.00.000</u>

TECHNISCHE ZEICHNUNG

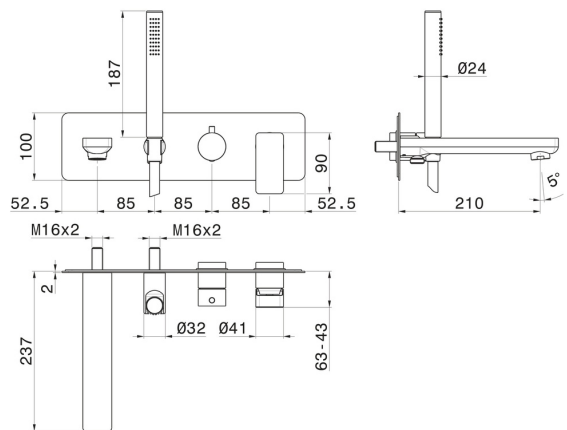



B-EASY

72672E.M0.075

Wandmontierte wannenbatterie - oberfläche Copper Glossy

VERFÜGBARE OBERFLÄCHEN

 **M0.075**
Copper Glossy

 **01.014**
oberfläche Weiß matt

 **01.093**
oberfläche Schwarz matt

 **21.018**
oberfläche Chrom

 **M0.070**
oberfläche Titanium Satin

 **M0.071**
oberfläche Gold Satin

 **M0.072**
oberfläche Copper Satin