

IONIKA

72838.01.093

Wandmontierter Auslauf für Waschbecken 1/2-Zoll-Armatur zum Einbau - oberfläche Schwarz matt

L=230 mm



Schwarz matt

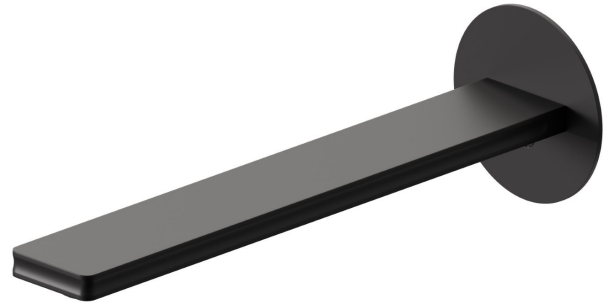

EIGENSCHAFTEN

Material	Messing
Technologie	Save Water
Installation	wandmontierte
Lochtyp	1-Loch

TECHNISCHE ZEICHNUNG

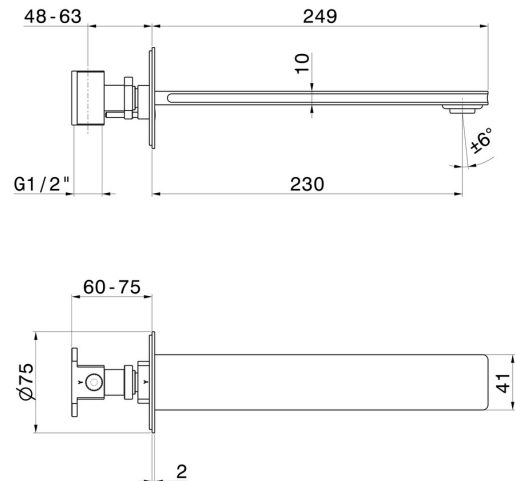



IONIKA

72838.01.093

Wandmontierter Auslauf für Waschbecken 1/2-Zoll-Armatur zum Einbau - oberfläche Schwarz matt

VERFÜGBARE OBERFLÄCHEN



01.093

Schwarz matt



01.014

oberfläche Weiß matt



21.018

oberfläche Chrom



59.064

oberfläche PVD Gun Metal gebürstet



59.066

oberfläche PVD Edelstahl



59.067

oberfläche PVD Copper Bronze gebürstet



59.098

oberfläche PVD Pale Gold gebürstet



61.020

oberfläche PVD Glossy Gold