

IONIKA

72838.61.020

Wandmontierter Auslauf für Waschbecken 1/2-Zoll-Armatur zum Einbau - oberfläche PVD Glossy Gold

L=230 mm



PVD Glossy Gold



EIGENSCHAFTEN

Material	Messing
Technologie	Save Water
Installation	wandmontierte
Lochtyp	1-Loch

TECHNISCHE ZEICHNUNG

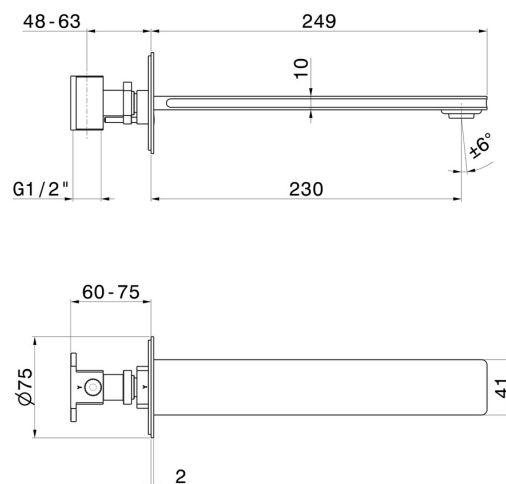



IONIKA

72838.61.020

Wandmontierter Auslauf für Waschbecken 1/2-Zoll-Armatur zum Einbau - oberfläche PVD Glossy Gold

VERFÜGBARE OBERFLÄCHEN



61.020

PVD Glossy Gold



01.014

oberfläche Weiß matt



01.093

oberfläche Schwarz matt



21.018

oberfläche Chrom



59.064

oberfläche PVD Gun Metal gebürstet



59.066

oberfläche PVD Edelstahl



59.067

oberfläche PVD Copper Bronze gebürstet



59.098

oberfläche PVD Pale Gold gebürstet